

**ASME/ANSI REQUIREMENTS  
ASME BOILER & PRESSURE VESSEL CODE  
Section 1 – Power Boilers (2013 Addenda) and  
ANSI B31.1 – Power Piping Code  
(2014 Addenda)  
(SEE NOTE 1)**

Index and Service	Reference	Comments
<b>A</b> Water Column Shut-Off Valves	BPV-1 PG 60.3.4 BPV-1 PG 60.3.7	Piping between water column and boiler to be 1 in. minimum size. Shut-off valves must be through-flow type. Must indicate whether the valve is open or closed. Must be locked or sealed open.
<b>B</b> Water Column Drain	BPV-1 PG 60.2.3	Minimum pipe size 3/4 in., to install a valved drain to a safe point of discharge.
<b>C</b> Stop Valves	ANSI B31.1 PARA. 122.1.7 (A) (A.1)	Each boiler discharge outlet (except safety valve or reheater connections), must be fitted with a stop valve. Valves OS & Y rising stem type are preferred.
<b>D</b> Stop Valves at Common Header	ANSI B31.1 PARA. 122.1.7 (A.3) "STOP - CHECK"	When two or more boilers are connected to a common header, or when a single boiler is connected to a header having another steam source, the connection from each boiler having a manhole opening shall be fitted with two stop valves having an ample free-blow drain between them. The preferred arrangement consists of one stop-check valve (located closest to the boiler) and one valve of the style and design described in (A.1). Alternatively, both valves may be of the style and design described in (A.1).
<b>E</b> Surface Blow-Off	BPV-1 PG 59.3.2	Surface blow-off shall not exceed 2 1/2 in. pipe size.
<b>F</b> Blow-Off Valves	BPV-1 PG 59.3.5 ANSI B31.1 PARA. 122.1.7 (C.1) (C.4) (C.5) (C.9) (C.10)	The minimum size of blow-off pipe and fittings shall be 1 in. The maximum size shall be 2 1/2 in. (See code of exceptions on miniature boilers and electric boilers). On boilers with 100 square feet or less of heating surface, 3/4 in. pipe and fittings may be used. Ordinary globe valves, and other valves with dams or pockets where sediment can collect, shall not be used on blow-off connections. Except for electric steam boilers having a normal water content of 100 Gal, traction-purpose, and portable boilers with allowable working pressure over 100PSIG, each bottom blow-off requires two slow-opening valves, or one quick opening valve at the boiler nozzle followed by a slow-opening valve. When the value of P required by para.122.1.4 (A.1) does not exceed 250 psig [1725 kPa (gage)], the valves or cocks shall be bronze, cast iron, ductile iron, or steel. The valves or cocks, if of cast iron, shall not exceed NPS 2 1/2 and shall meet the requirements of the applicable ASME standard for Class 250, as given in Table 126.1, and if of bronze, steel, or ductile iron construction, shall meet the requirements of the applicable standards as given in Table 126.1 or para. 124.6. Boilers with multiple blow-off pipes may have single master valve on common header with single blow-off valve on each individual pipe. either master or individual blow-off valves shall be slow opening. Two independent slow opening valves, or a slow opening and a quick opening valve, may be combined in one body provided it is the equivalent of two separate valves and that the failure of one cannot affect the other.

NOTE 1: These guide lines are based on ASME and ANSI codes at time of printing and are intended to assist you in valve selection. However, they are subject to changes in the codes as they may occur. The actual codes should always be consulted for full details and requirements.

**BOILER VALVE MOUNTINGS**

Refer to the following table for proper Valve to use at each location designed by index letter.

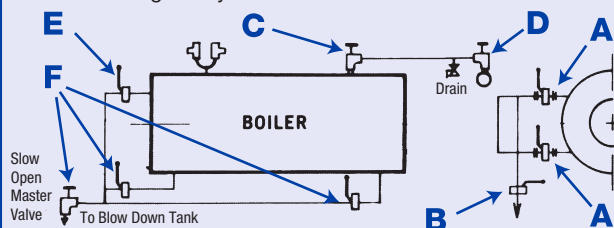

**OPTIONAL BOILER VALVE MOUNTINGS**

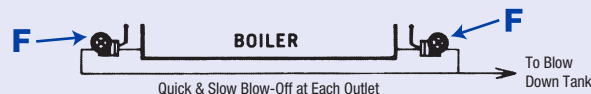

# BOILER VALVE selector guide

**TO MEET ASME/ANSI REQUIREMENTS  
ISO 9001 CERTIFIED COMPANY**



**LATEST APPLICABLE CODES**

- ASME SECT. 1 - 2013 POWER BOILERS**
- ANSI B31.1 - 2014 POWER PIPING**
- ANSI B16.1 - 2010 CAST IRON FLANGES & FITTINGS**
- ANSI B16.5 - 2013 PIPE FLANGES & FLANGED FITTINGS**
- ANSI B16.34 - 2013 VALVES – FLANGED, THREADED & W.E.**

# EVERLASTING® QUICK OPENING VALVES MEET ASME/ANSI CODE (INDEX B, E, F)

PRESSURE RATING PSIG			Figure No.	End Type	Body Matl.	Available Sizes - Chart shows suggested Operating Pressure limits for easy operation with standard lever and Geared lever. Longer levers are available for higher pressure upon request.				
Primary Service Rating	Max. Blow-Off Service †	Suitable for Use with Index Letter				1"	1 1/4"	1 1/2"	2"	2 1/2"
250	200	B,F	4000-A	SCR	Iron	250	250	200	200	100
			4001-A	FLG	Iron	250	250	200	200	100
			4010-A	SCR	Iron	—	—	250	215	150
			4011-A	FLG	Iron	—	—	250	215	150
300	485	B,F	4000-S (57)	SCR	Steel	400	300	200	200	100
			4001-S (57)	FLG	Steel	400	300	200	200	100
			4010-S (57)	SCR	Steel	—	—	300	215	150
			4011-S (57)	FLG	Steel	—	—	300	215	150
600	910	B,F	4000-S (58)	SCR	Steel	550	450	270	200	100
			4001-S (58)	FLG	Steel	550	450	270	200	100
			4010-S (58)	SCR	Steel	—	—	300	215	150
			4311-S (58)	FLG	Steel	—	—	300	215	150

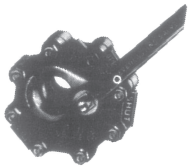

Fig. 4000 Series Lever Operated

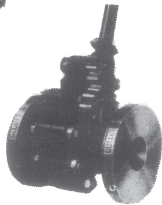

Fig. 4001 Series Lever Operated

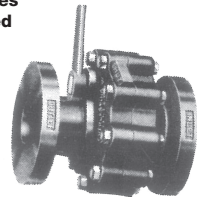

Fig. 4011, 4311 Series Lever & Gear Operated  
4010 Series Not Illustrated

### Features

- Straight-through flow
- Leak proof seal disc has self lapping action, actually improves with use.
- Self wiping action of disc – cannot hang-up on boiler scale

### How figure 4000 Series operates

Line pressure and heavy spring hold disc firmly against the body seat, sealing off the flow. When operated, the disc slides across the body seat pushing harmful boiler scale away, and wiping clean the precision lapped surface.

Hand adjustment of the post packing is eliminated. Post packing is **self-adjusted** by a spring and line pressure. This prevents destructive erosion and leakage of stuffing box.

## MATERIAL DATA

Figure No.	Body	Post	Disc	Seat Bushing	Lever Arm	Post Packing	Springs	Body Gasket	Operating Wrench
4000-A 4001-A	Cast Iron	Forged Bronze	Cast Iron	—	Ductile Iron	V-Ring Packing	17-7PH	Corrugated Stainless Steel	Forged Steel
4000-S (57) 4001-S (57)	Steel	Forged Bronze	Hard Stainless	Hard Stainless	Ductile Iron	V-Ring Packing	17-7PH	Corrugated Stainless Steel	Forged Steel
4010-A 4011-A	Cast Iron	Forged Bronze	Cast Iron	—	Ductile Iron	V-Ring Packing	17-7PH	Corrugated Stainless Steel	Ductile Iron
4010-S (57) 4011-S (57)	Steel	Forged Bronze	Hard Stainless	Hard Stainless	Ductile Iron	V-Ring Packing	17-7PH	Corrugated Stainless Steel	Ductile Iron
4000/4001-S (58) 4010/4311-S (58)	Steel	17-4 PH Stainless	Hard Stainless	Hard Stainless	Ductile Iron	Non-Asbestos	17-7PH	Corrugated Stainless Steel	Ductile Iron

## DIMENSIONAL DATA

Rating	Figure No.	Dimension Letter	Size					2 1/2"	
			1"	1 1/4"	1 1/2"	2"	2 1/2"	(57)	(58)
250	4000-A	F	3 5/8	3 5/8	4 1/2	4 5/8	5 1/4		
300/600	4000-S (57)(58)	++F	5	5 1/4	6	6 1/4		13 3/8	13 3/8
300/600	4002-S (57)(58)	++F	6 1/8	6 3/8	6 7/8	7 7/8		14 3/4	14 3/4
250	4001-A	B	7 1/2	7 1/2	8 3/8	9	10 3/8		
300	4001-S (57)	B	7 5/8	7 7/8	8 7/8	9	12		
600	4001-S (58)	B	8 1/2	9	10 1/2	11 7/8	15		
250/300	J	J	4	4 3/4	5 1/4	5 1/4	6 1/4		
		L	9	9	15 1/4	15 1/4	23		
600	O	O	18 5/8	18 5/8	15 1/4	15 1/4	23		
		S	5°	55°	55°	60°	60°		
		S	1 5/8	1 3/4	2 1/8	2 1/16	2 3/4		

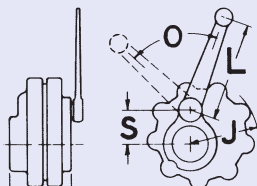

Fig. 4000 Series

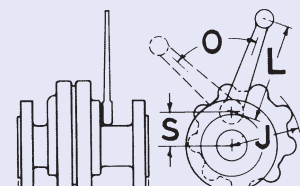

Fig. 4001 Series

Rating	Figure No.	Dimension Letter	Size			Rating	Figure No.	Dmsn Letter	Size			2 1/2"	
			1 1/2"	2"	2 1/2"				1 1/2"	2"	2 1/2"	(57)	(58)
250	4010-A	F	4 1/2	4 5/8	5 1/4	300/600	4010-S (57)(58)	++F	6	6 1/4		13 3/8	13 3/8
250	4011-A	B	8 3/8	9	10 3/8	300/600	4012-S (57)(58)	++F	6 7/8	7 7/8		14 3/4	14 3/4
	J	J	5 3/4	6 1/4	7 3/4	300	4011-S (57)	B	8 3/4	9	12		
	L	L	18 1/4	18 3/8	23	600	4011-S (58)	B	10 1/2	11 7/8	15"		
	L <sup>S</sup>	L <sup>S</sup>	12 1/2	12 1/2	15 1/2		J	J	5 1/4	5 1/4	6 1/4		
	O	O	130°	130°	120°		L	L	18 1/4	18 3/8	23		
	S	S	5	5 1/4	6 3/4		L <sup>S</sup>	L <sup>S</sup>	12 1/2	12 1/2	15 1/2		
							O	O	130°	130°	120°		
							S	S	4 1/2	4 1/2	6 3/4		

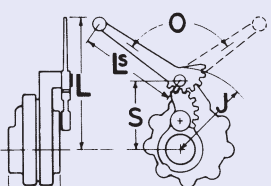

Fig. 4010 Series

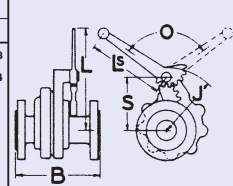

Fig. 4011 Series

**TO SPECIFY** — Everlasting Quick Opening Blow-Off Valve(s): figure number(s) \_\_\_\_\_, size \_\_\_\_\_, lever operated, sliding disc packless seating, bolted split body, for \_\_\_\_\_ lbs. meeting ASME/ANSI code.

**TO ORDER** — Use figure number(s), state size, body material, type connection, for \_\_\_\_\_ lbs.

†Pressures shown are maximum allowed by ASME Code.  
++New F to F for 2 1/2" valves.

# EVERLASTING® SLOW OPENING VALVES MEET ASME/ANSI CODE (INDEX B, C, D, E, F)

PRESSURE RATING PSIG			Figure No.	End Type	Body Matl.	Available Sizes - Chart shows suggested Operating Pressure limits for easy operation with standard lever and Geared lever. Longer levers are available for higher pressure upon request.				
Primary Service Rating	Max. Blow-Off Service †	Suitable for Use with Index Letter				1"	1 1/4"	1 1/2"	2"	2 1/2"
250	200	B,F	4060-A	SCR	Iron	250	250	250	250	250
			4061-A	FLG	Iron	—	—	250	250	250
			B-6561	FLG	Iron	—	—	250	250	250
			B-6571	FLG	Iron	—	—	250	250	250
300	485	B,F	4060-S (57)	SCR	Steel	605	605	605	605	605
			4061-S (57)	FLG	Steel	605	605	605	605	605
			B-6661	FLG	Steel	—	—	605	605	605
			B-6671	FLG	Steel	—	—	605	605	605
600	910	B,F	4060-S (58)	SCR	Steel	935	935	935	935	935
			4061-S (58)	FLG	Steel	935	935	935	935	935
			B-6761	FLG	Steel	—	—	935	935	935
			B-6771	FLG	Steel	—	—	935	935	935

## Features

- Valve can be installed with hand wheel in any position.
- Straight-through-flow.
- Leak proof seal-disc has self lapping action, actually improves with use.
- Seal-disc has self wiping action; cannot hang-up on boiler scale.
- No retightening after cool down; seal not affected by temperature change.
- Real slow opening.
- Hard seat resists erosion.

## How figure 4060 and 4061 Series operate



Line pressure and heavy spring hold disc firmly against the body seat, sealing off the flow. When operated, the disc slides across the body seat pushing harmful boiler scale away, and wiping clean the precision lapped surfaces.

Hand adjustment of the post packing is eliminated. Post packing is **self-adjusted** by a spring and line pressure. This prevents destructive erosion or leakage of stuffing box.

## Sectional View of Angle and "Y" Valve

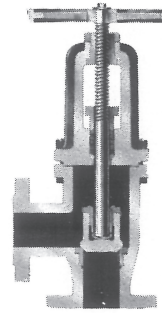

## How figure 6000 Series operates

These valves are of the outside Screw and Yoke type. The seat and disc are capable of withstanding the severe erosive flow of blow-down service. While quick opening Valve holds boiler water, the seat and disc can be easily removed for repair without removing the Valve from line.

## MATERIAL DATA

Figure No.	Body	Post	Disc	Seat Bushing	Lever Arm	Post Packing	Springs	Body Gasket	Clevis Nut	Handwheel	Lever	Screw Shaft
4060-A 4061-A	Cast Iron	Forged Bronze	Cast Iron	Hard Stainless	Ductile Iron	V-Ring Packing	17-7PH	Corrugated Stainless Steel	Iron	Iron	Ductile Iron	Steel
4060-4061S (57) 4060-4061S (58)	Carbon Steel	Forged Bronze 17-4PH	Hard Stainless	Hard Stainless	Ductile Iron	V-Ring Packing Non-Asb.	17-7PH	Corrugated Stainless Steel	Iron	Iron	Ductile Iron	Steel

Figure No.	Body	Yoke	Disc	Seat	Stem	Yoke Nut	Yoke Lock Nut	Yoke Bushing	Gland	Packing	Seat Gaskets	Body Gasket
B6561 B6571	Cast Iron	Cast Iron	Hard Stainless	Stainless	Stainless Steel	Bronze	Bronze	Bronze	Ductile Iron	Comp. Fiber	Grafoil	Grafoil
B6661 B6671	Cast Steel	Cast Steel	Hard Stainless	Stainless	Stainless Steel	Bronze	Bronze	Bronze	Ductile Iron	Comp. Fiber	Grafoil	Grafoil
B6761 B6771	Cast Steel	Cast Steel	Hard Stainless	Stainless	Stainless Steel	Bronze	Bronze	Bronze	Ductile Iron	Comp. Fiber	Grafoil	Grafoil

## DIMENSIONAL DATA

Rating	Figure No.	Dimension Letter	Size				
			1"	1 1/4"	1 1/2"	2"	2 1/2"
250	4060-A	F	3 5/8	3 5/8	4 1/2	4 5/8	5 1/4
250	4061-A	B	—	—	8 3/8	9	10 3/8
		H	8	8	10	10 1/2	10 1/2
		J	13	13	14	14	15 1/2
		N	9	9 1/2	12	12 1/2	13 1/2
		S	5	5	5 1/2	5 1/2	5 1/2
		W	9	9	9	9	9

Rating	Figure No.	Dimension Letter	Size		
			1 1/2"	2"	2 1/2"
250/300	B6561/B6661	E	4 1/4	5	6
		G	5	5 1/2	5 3/4
		H-Shut	14 1/2	15 3/8	16 3/8
600	B6761	H-Open	16 1/2	17 7/8	19 3/8
		E	4 5/8	5 1/4	6 1/4
		G	5 3/8	6	6 1/4
		H-Shut	14 1/2	15 3/8	15 7/8
		H-Open	16 1/2	17 7/8	18 7/8

Rating	Figure No.	Dimension Letter	Size				
			1"	1 1/4"	1 1/2"	2"	2 1/2"
300/600	4060-S (57)(58)	++F	5	5 1/4	6	6 1/4	13 3/8 13 3/8
300/600	4062-S (57)(58)	++F	6 1/8	6 3/8	6 7/8	7 7/8	14 3/4 14 3/4
300	4061-S (57)	B	7 5/8	7 7/8	8 3/4	9	12
600	4061-S (58)	B	8 1/2	9	10 1/2	11 7/8	15
		H	7 1/4	7 1/4	7 1/4	9 1/2	
		J	11 1/2	12	12	12 1/2	16
		N	11	10	10 1/2	13	13
		S	4 3/4	4 3/4	5 1/8	5 1/8	6 1/2
		W	9	9	9	9	12

Rating	Figure No.	Dimension Letter	Size		
			1 1/2"	2"	2 1/2"
250/300	B6571/B6671	B	12 1/4	12 3/4	14 1/4
		H-Open	15 3/4	17 1/4	18 1/2
		X-Open	6 5/8	7 3/8	7 5/8
600	B6771	B	12 7/8	13 1/2	15
		H-Open	16 1/8	17 3/4	19 1/8
		X-Open	6 1/2	7 3/8	7 7/8

TO SPECIFY — Everlasting Slow Opening Blow-Off Valve(s):  
figure number(s) \_\_\_\_\_, size \_\_\_\_\_, wheel operated,  
sliding disc packless seating, for \_\_\_\_\_ lbs. meeting  
ASME/ANSI code.

TO SPECIFY — Everlasting Slow Opening Blow-Off Valve(s):  
figure number(s) \_\_\_\_\_, size \_\_\_\_\_, wheel operated,  
rising stem, packless seating disc type, for \_\_\_\_\_ lbs.  
meeting ASME/ANSI code.

†Pressures shown are maximum allowed by ASME Code.  
++New F to F for 2 1/2" valves.

TO ORDER — Use figure number(s), state size, body material, type connection, for \_\_\_\_\_ lbs.

# DUPLEX & UNITANDEM VALVES MEET ASME/ANSI CODE (INDEX "F")

STANDARD BOILER VALVE Q/SL FLANGED END 5061L

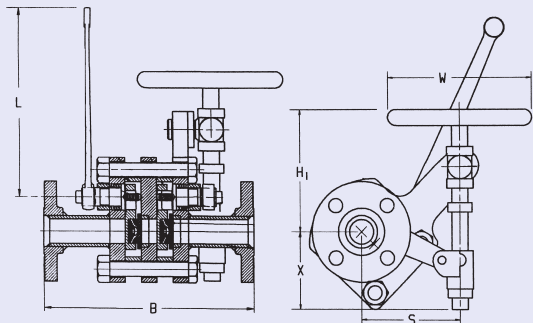

RATING 300 LB

Fig. 5061L	DIMENSION					
	B	H <sub>1</sub>	L	S	W	X
1 1/2	12 1/2	8 1/2	12 1/5	5	9	4 1/8
2	12	8 1/2	18	5	9	4 1/8

STANDARD BOILER VALVE Q/SL FLANGED END 5061R

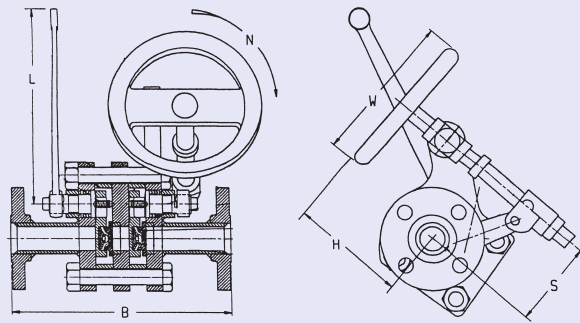

RATING 300 LB

Fig. 5061R	DIMENSION					
	B	H	L	N	S	W
1 1/2	11 1/2	6 1/2	12 1/2	10 1/2	5	9
2	12	7	18	13	5	9

## How figure 5000 series operate

A combination of quick and slow opening Valves in one body operates the same as figure 4000 series described on pages 2 and 3. The lever operated section is used as the sealing Valve and the handwheel operated section is the blowing Valve. The blowing Valve can be removed for repair while the sealing Valve remains in service (Fire Banked).

All Valve bodies are made of carbon steel and are easy to operate at maximum blow-off pressure.

TO SPECIFY—Enter figure number(s) \_\_\_\_\_, size \_\_\_\_\_, and \_\_\_\_\_ lbs.

TO ORDER—Use figure number(s), state size, body material, type connection, for \_\_\_\_\_ lbs.

## DUPLEX VALVES

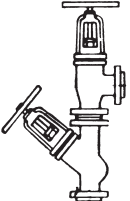
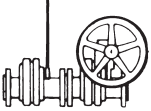
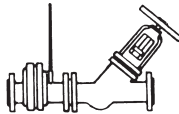
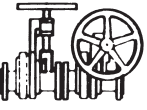
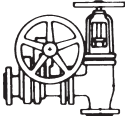
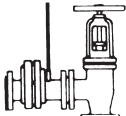
 <p><b>Two Slow Opening</b> 250 LB. B6571/B6561 300 LB. B6671/B6661 600 LB. B6771/6761</p>	<p><b>One Quick — One Slow Opening</b> 250 LB. 4000A/4060A 4001A/4061A 4010A/4060A 4011A/4061A 300/600 LB. 4000S (57)(58) / 4060S (57)(58) 4001S (57)(58) / 4061S (57)(58) 4010S (57)(58) / 4060S (57)(58) 300 LB. 4011S (57) / 4061S (57) 600 LB. 4311S (58) / 4061S (58)</p> 	<p><b>One Quick — One Slow Opening</b> 250 LB. 4001A / B6571 4011A / B6571 300 LB. 4001S (57) / B6671 4011S (57) / B6671 600 LB. 4001S (58) / B6771 4311S (58) / B6771</p> 
<p><b>Two Slow Opening</b> 250 LB. 4060A / 4060A 4061A / 4061A 300 LB. 4060S (57)/4060S (57) 4061S (57)/4061S (57) 600 LB. 4060S (58)/4060S (58) 4061S (58)/4061S (58)</p> 	<p><b>One Quick — One Slow Opening</b> 4061A / B6561 4061S (57) / B6661 4061S (58) / B6761</p> 	<p><b>One Quick — One Slow Opening</b> 250 LB. 4001A / B6561 4011A / B6561 300 LB. 4001S (57) / B6661 4011S (57) / B6661 600 LB. 4001S (58) / B6761 4311S (58) / B6761</p> 

For detailed ratings and operating pressures see figure number of Valve on pages 2 and 3. TO SPECIFY—See data on pages 2 and 3.

TO ORDER—Use figure number combination shown above, state size, body material, type connection, for \_\_\_\_\_ lbs.

## DISTRIBUTED BY



EVERLASTING VALVE COMPANY, INC.

108 Somogyi Court • So. Plainfield, New Jersey 07080

(908) 769-0700 • FAX (908) 769-8697

email: info@everlastingvalveusa.com

www.everlastingvalveusa.com