



cyclonaire[®]
pneumatic conveying solutions

Right Solution. Total Solution. Lifetime Solution.

cyclonaire.com

Mining for better solutions

For more than 40 years, we've been designing equipment around specific material and application needs for the mineral industry. By digging in to understand your process and what you want to accomplish, we'll develop a solution that aligns with your unique requirements. Our expertise spans a long list of minerals and particle sizes, from alumina to zircon.

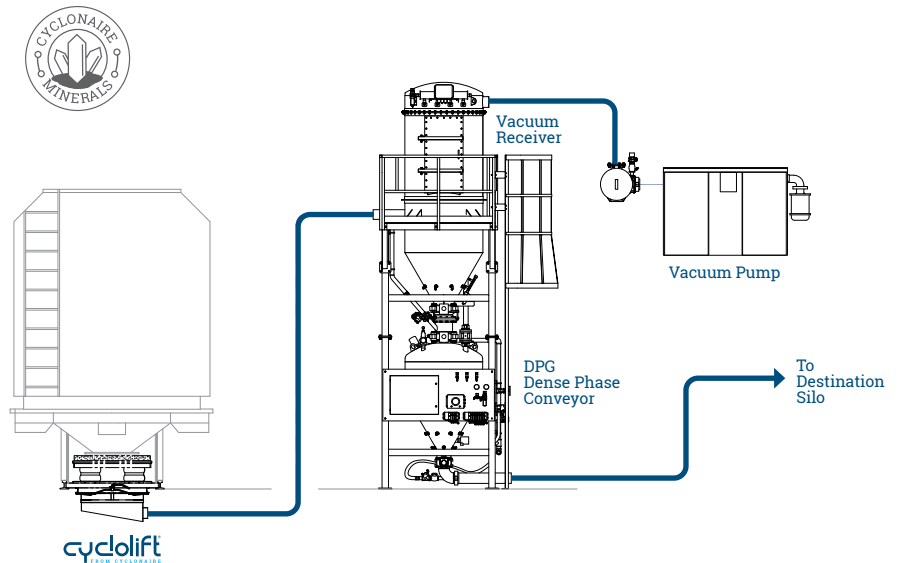

Come clean with Cyclonaire®

One thing we don't have is tunnel vision for one piece of equipment. We design and build a variety of conveyance solutions that align with the individual needs of each manufacturer. Because rubber production is a dirty business, we produce equipment that can be easily air purged and used to convey a variety of material without fear of contamination. And to make sure your Cyclonaire solution performs as promised, we preassemble and test both equipment and materials. Our equipment delivers greater efficiencies, including reduced batch loading times.

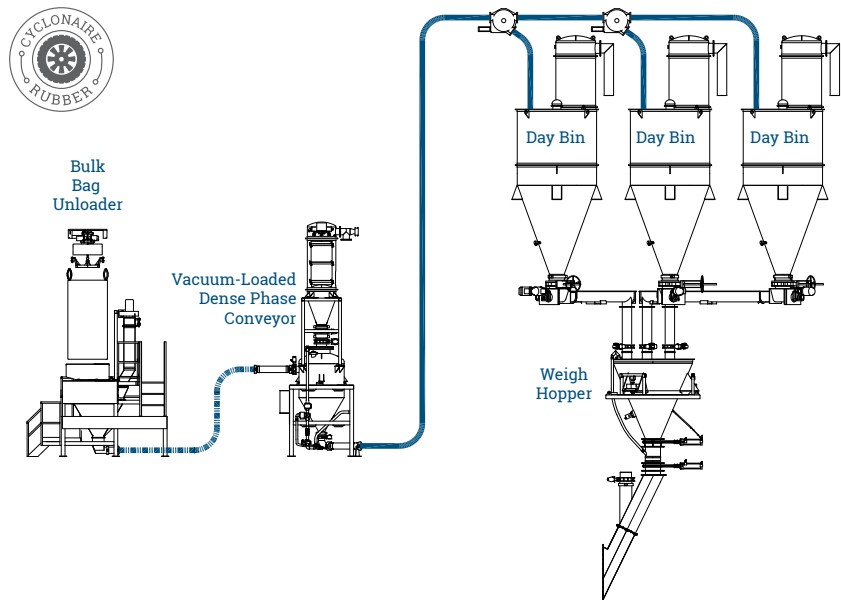

Gummy Bears to Rocket Fuel.

Our core competency and focus lies in the cement, mineral, rubber, rail sanding, and battery industries. Over our 45+ years of business, however, we have conveyed just about everything, including gummy bears, rocket fuel and fermented seaweed. We also have particular expertise for solutions such as rail unloading, regardless of what is in the railcar.

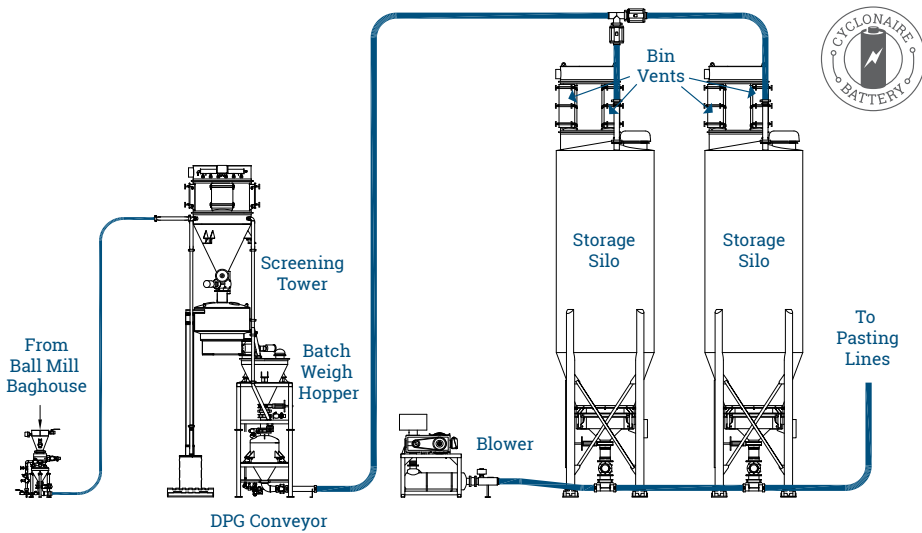

It's a tough business.

Working with hazardous materials like lead oxide requires care, expertise and Cyclonaire equipment for improved safety and accuracy. Manufacturers seek us out because of our in-depth knowledge of materials and our expertise in providing higher levels of control. Our equipment eliminates spills and promotes greater safety because material stays in the pipes where it belongs. For clean operation, the ability to quickly and easily change destinations, and sophisticated automation choose Cyclonaire pneumatic solutions.

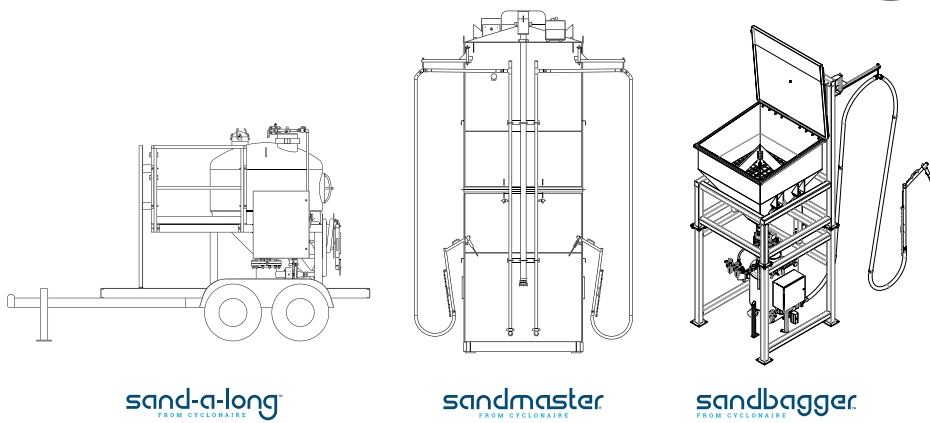

The rail industry never sleeps. Neither do we.

Whether you're a Class 1 or a short line, our sanding equipment gives you the traction to keep running. Cyclonaire pneumatic conveyance innovations have made sanding easier and more efficient. But safety is our number one priority. With our equipment, service platform workers don't have to climb on top of silos – they stay on the ground and use a wand to distribute sand. By keeping boots on the ground, we protect against injury. We work hand in hand with you and your engineers to design equipment that fits the configuration of your service platform and sand transfer process.

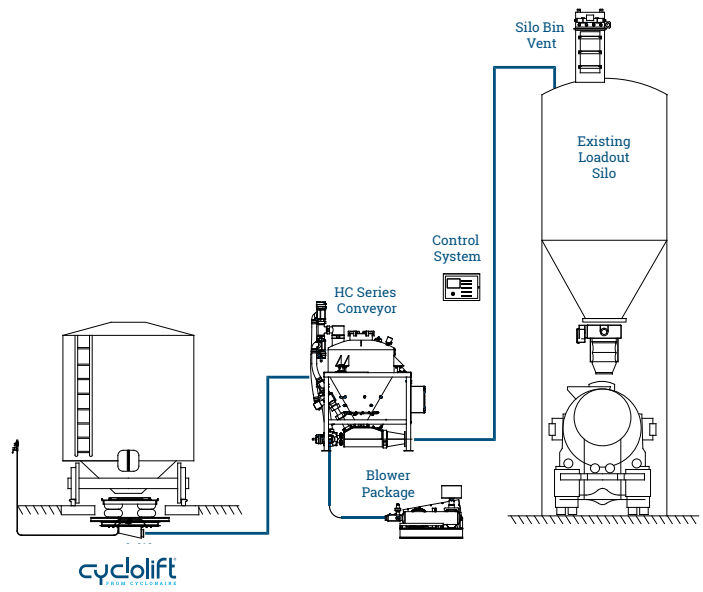

No pit. No worries.

As an industry leader, our pneumatic conveyance solutions stand up to the toughest cement production challenges. Our equipment is well designed for its purpose. It's tough. We build in abrasion-resistance features to reduce unscheduled down time. And it's airtight to keep moisture out of the process. Cyclonaire cement materials handling equipment doesn't require a pit and can be installed above grade for ease of operation and greater safety. For robust equipment designed for low maintenance and high productivity, your best solution is Cyclonaire.



Dense

High Pressure, Low Velocity

Dense phase pneumatic conveying is a relative-velocity system where the material is not suspended in the airstream. The low velocity of dense phase means less wear and tear on both the system and materials being conveyed.

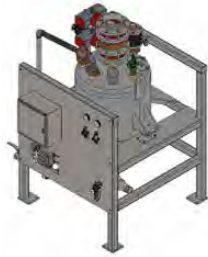

DPG Series

Gravity-loaded, bottom discharge transfer with 400+ TPH capacity makes light work of heavy loads. For transferring powdered, granular or pelletized products, nothing compares to the productivity of our bottom discharge conveyors (DPG-B). Using higher pressure air at lower conveying velocities to achieve high material-to-air ratios, DPGs minimize degradation and abrasive wear.

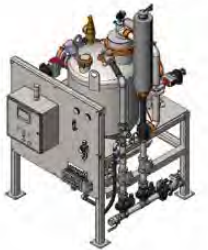

DPV Series

Nothing delivers greater flexibility than our dense phase vacuum-loaded conveyors. These precisely engineered pneumatic conveyors allow you to unload bulk bags, trucks and/or railcars with minimal product degradation.



CycloLok™

The CycloLok is a gravity loaded, bottom discharged low-volume, dense phase conveyor with only one moving part. It is best suited for highly abrasive and friable materials in especially harsh environments, such as high temperature dust reclaim. Capacity is rated to 2 TPH and temperature is rated to 450 °F.



Air Injectors

The injectors are strategically positioned along the convey-line piping to control slug length for smoother dense phase conveying. Cyclonaire's patented convey line injectors improve flow by being expertly set up-on site by our trained field technicians. Sized for pressure and flow depending on your material, these robust injectors provide long-term, reliable service.



Filter and Vacuum Receiver

Filter and Vacuum Receivers are used for integrating dust filtration or separation into pneumatic conveying systems with larger pressure fluctuations requiring more plenum rigidity. They feature a round design for standard pressure rating of -15" Hg / +2 psig, making them well suited for both pressure or vacuum convey applications. Custom heavier duty options are available for full vacuum and 14.5 psig pressure.



Semi-Dense

Medium Pressure, Medium Velocity

Semi-dense phase, the intermediary step between dense and dilute phases, conveys materials using a medium velocity. Only a portion of materials are suspended in the air system.



HC Series

The HC conveyor is a high capacity, side inlet, vacuum loaded, semi-dense phase conveyor with a capacity to 100+ TPH. It is best suited for powdered materials that are abrasive or fluidizable. Medium pressure blower air is used to venturi-induced vacuum load and pressure convey air at intermediate line velocities and material-to-air ratios for less abrasive wear and particle degradation. Integral dust separation is included.



GF Series

The GF Series is designed for material transfer conditions where a rotary valve is not desired. This material feed device is a high capacity, gravity loaded, semi-dense phase conveyor with a range of capacities up to 100+TPH. It is suited for powder, pellets or granular materials. Medium pressure blower air is used to pressure convey material air at intermediate line velocities and higher material-to-air ratios for less abrasive wear and particle degradation than dilute phase systems.



CB Series

With Blend-Veyors, you can blend and convey two or more materials in one unit for greater efficiency and less product degradation. These products feature vacuum-loaded, semi-dense phase blending and conveyance with a capacity up to 80 TPH. Blend-Veyors use a single 15 psig positive displacement blower for vacuum-pressure conveying at intermediate-line velocities (<2000–5000 fpm) and high material-to-air ratios, reducing material degradation and abrasive line wear.



CycloLift®

Unloading hopper bottom railcars and trucks has never been easier with the CycloLift connectors. CycloLift's specifically designed connectors install easily between existing tracks to reduce time and help eliminate costly spills and cleanup. Pneumatic lifters elevate the unit as the hopper empties, maintaining a positive seal.

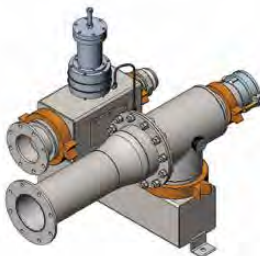

Turbo-Inductor®

Cyclonaire's Turbo-Inductor systems offer faster unloading from pneumatic trailers and railcars. These self-contained systems work by stepping up to larger diameter convey lines and adding higher volumes of air to the conveyed bulk material – without any modifications to the delivery vehicles.



Air Shoot™

The Air Shoot is an incredibly simple yet effective low pressure, air-activated gravity conveyor for transferring fluidizable materials. Material is moved in a near horizontal plane with minimal changes in elevation for layouts with low headroom or small vertical height differential between source and destination points. Available in open and closed (dust free) models and can be manufactured to your specifications.



Collect and Convey® (C&C)

The automated Collect and Convey (C&C) Reclaim System preserves air quality and conserves valuable material by capturing airborne product dust from silo filling operations and automatically returning it directly to source silos. Each unit combines an efficient Cyclonaire Pulse Jet Dust Collector with a rugged, gravity-fed CycloLok Dense Phase Pneumatic Conveyor that operates on plant air and runs only when needed.



Surge Hopper

Cyclonaire surge hoppers are available in a wide range of sizes to meet all of your demanding and diverse working and intermediate storage needs. The surge hoppers include inlet flange, vent connection, level sensor connection and outlet flange.

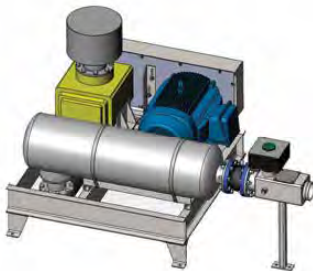

Blower Package

Custom built pressure blower packages can be designed for a wide variety of applications, including dilute and semi-dense conveying as well as providing bin, hopper and silo aeration requirements. Each blower package is engineered for your application's elevation and temperature.



Dilute

Low Pressure, High Velocity

Dilute phase is a high-velocity system where the conveyed material is continuously suspended in the air as it is blown or sucked through the pipeline. Material does not accumulate at the bottom of the convey line at any point.



Rotary Valve

The Rotary Airlock can be used for any free-flowing materials. Includes custom rotor types to suit various applications and materials – powders, granules and pellets.



While there are many complexities and subcategories that fall under the umbrella of pneumatic conveying, the technology can be broken down into three categories: dense phase, semi-dense phase and dilute phase. Understanding each of these phases will help you determine the best choice for your specific application. Some technologies apply to more than one phase. Below are technologies featured in all three phases.



Bin Vent

The Bin Vent/Dust Collectors provide excellent filtration at destination points such as bins, hoppers and silos. Automatic timers clean the filter media with pulse jet reverse flow air, dropping retained material back into the process. These are designed to handle any dry bulk material conveyed pneumatically.



Pinch Diverter Valve

Cyclonaire's Pinch Diverter Valve is a proven application for all three conveyance phases. It is ideal for multiple source convergence as well as multiple destination divergence. The valve provides obstruction-free flow and is custom built to fit any possible configuration.



Bulk Bag Unloader

Bulk Bag Unloaders are designed to be easily customized for safe handling and clean unloading of any free-flowing, dry bulk material in bags. The simple bag interface design accommodates all bulk bag spout styles, allowing an operator to easily untie a bag through the oversized access door.

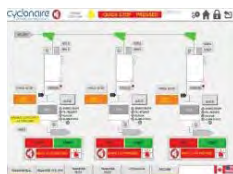

PLC/Automation

Cyclonaire's automation systems are a customized control option for individual units or integrated systems. Options are available for software and hardware for single machines, as well as for systems integrating several machines into a single control architecture.

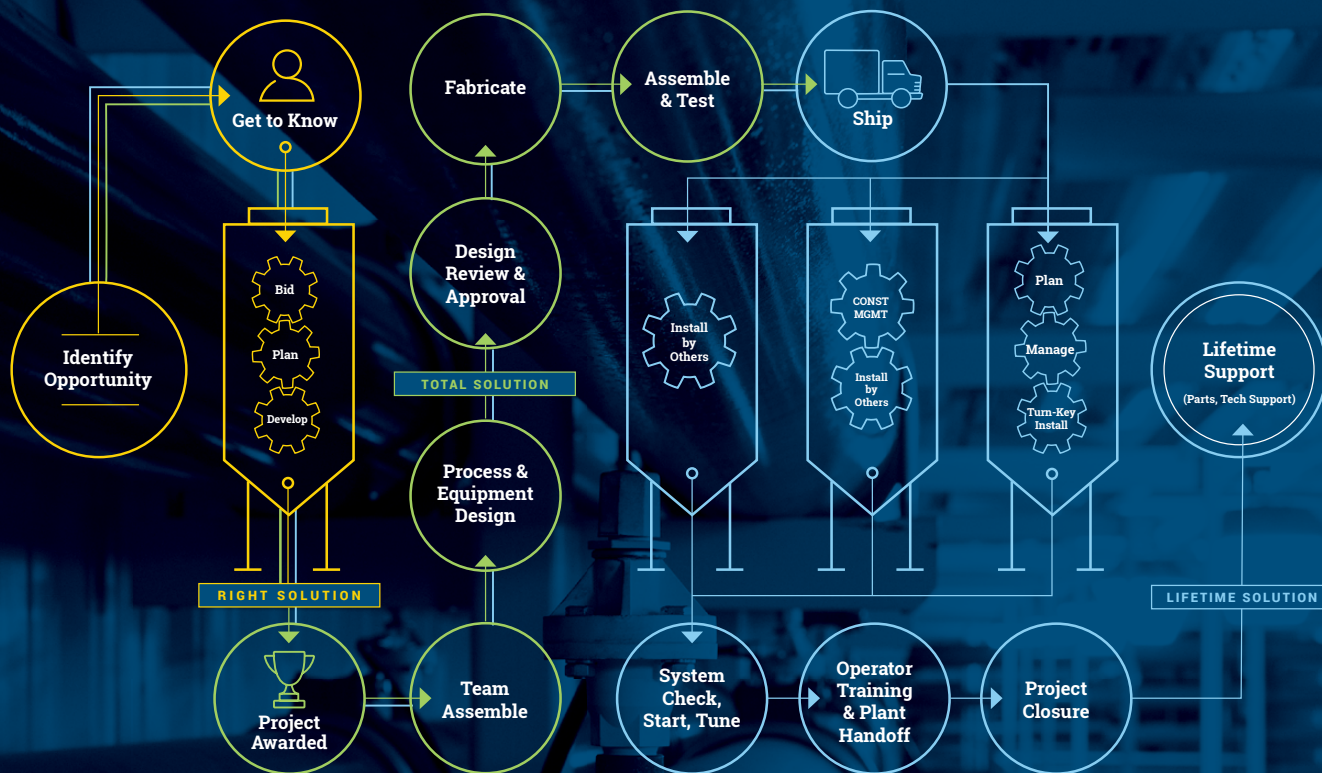

Cyclonaire's Proven Process

Right Solution

We arrive at the right solution by establishing a close working relationship with our customers. A local Cyclonaire representative and a direct specialist serve as front-line partners working to understand what customers need to solve complex, multifaceted, multidisciplinary conveyance and materials handling issues.

Total Solution

We assemble a dedicated team of designers, materials specialists and project managers to take projects from creation through fabrication, installation and testing. The result is a total solution created, executed and cared for by highly skilled, detail-oriented materials handling experts who take pride in what they do, always with a positive attitude.

Lifetime Solution

Our involvement doesn't end there. We deliver a lifetime solution with our comprehensive service program and follow-up support, including system check, training, tech support and parts fulfillment.

cyclonaire
pneumatic conveying solutions

Questions? We have answers.

(800) 445-0730 | sales@cyclonaire.com