



APEX DOMES BY TANK CONNECTION

EMPLOYEE OWNED | AMERICAN MADE | GLOBAL LEADERS





COVERING THE DETAILS FROM START TO FINISH



DON'T COMPROMISE. GET CONNECTED.

THE APEX OF PRECISION ENGINEERED COVERS

APEX Domes by Tank Connection represents the highest quality aluminum dome available. Proprietary components, and precision manufacturing allows for a dome cover that features enhanced structural strength and increased flexibility. Advanced design creates superior leak protection, maximum vapor loss protection and enhanced load capacity.

WE WILL EXCEED YOUR EXPECTATIONS

Tank Connection is committed to helping clients find success with their projects. It is the utmost devotion to the customer that drives an unyielding pursuit of excellence that is the embodiment of Tank Connection.

WE TAKE QUALITY PERSONALLY

Tank Connection is an employee owned company, manufacturing American made products in ISO 9001:2015 Certified QMS facilities in the U.S. Tank Connection has built a reputation of success with a passion for safety, innovation and continuous improvement.

**PROPRIETARY
DESIGN**

**INDUSTRY
EXPERTS**

**SUPERIOR
QUALITY**

**STRENGTH +
FLEXIBILITY**

**EMPLOYEE OWNED
AMERICAN MADE**

**ENGINEERING
EXCELLENCE**

**PRECISION
FABRICATION**

**GOLDEN RULE
CUSTOMER SERVICE**

THE APEX DOMES ADVANTAGE

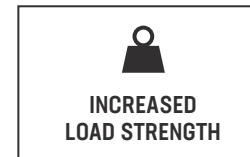
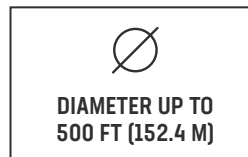
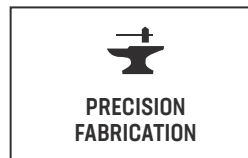
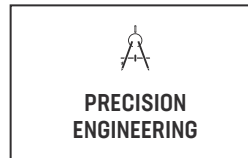
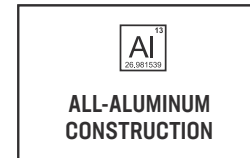

ENHANCED DESIGN

The specialized design of an APEX Dome is the result of experience, ingenuity and a persistent drive for excellence. All the components of an APEX dome are specifically engineered to achieve the highest performance possible. The end result is a premier dome design that maximizes strength and flexibility with enhanced protection against leaks, vapor loss and product loss.

Our focus on product quality and industry knowledge translates to a reliable dome cover with an extended service life.

APEX Domes uses the latest 3D modeling and Finite Element Analysis in our proprietary design software.

Structural components are cut and drilled using CNC machinery to ensure a precision fit in the field. This equates to expedient dome installation and optimum cost efficiency.

AVAILABLE DESIGN CODES

- API 650 App. G
- API 2000
- AWWA D108/
D103/D100
- NFPA 30
- ASCE 7-05
- ADM 2005/
2010/2015
- NFPA 22

BATTEN BAR SYSTEM

Our batten bar is designed as a positive sealing system, which compresses the gasket between the batten and the panel. In addition, the panel edge is designed such that when the batten bar is fully installed, the panel is compressed into the gasket.

The batten bar attachment center groove is designed so that fasteners can be installed and removed in the same position multiple times utilizing the tri-lobe style screw.

APEX Domes beam design includes flange stiffeners for enhanced rigidity. The unique strut design offers a stronger geometry with reduced weight for maximum design efficiency. The batten legs are also designed to prevent twisting with added load weight is applied.

An APEX Domes batten bar system provides redundant protective features against leaking.

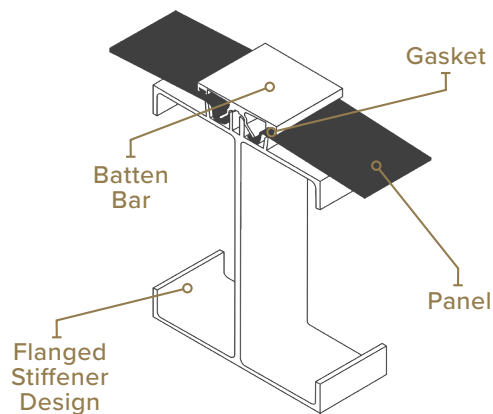
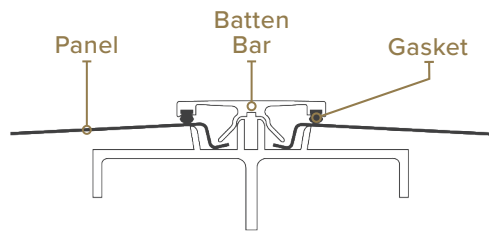

NODE DESIGN

An APEX Domes engineered node detail utilizes a proprietary extrusion design. The spun aluminum gusset cover provides a precision seal. Each node plate is etched marked for identification and orientation to aid in field installation.

NODE DETAIL
EXTRUSION DESIGN



SPUN ALUMINUM
GUSSET COVER

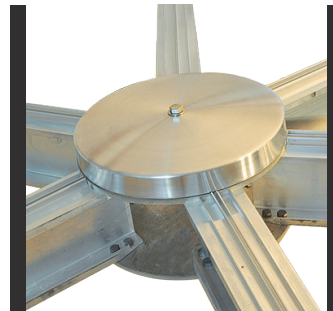

SLIDING SHOE DESIGN

APEX Domes can supply either a sliding shoe or fixed pier design. Our proprietary sliding shoe design allows the dome components to relieve stress in both wind and downward loading conditions such as snow or ice. Other dome manufacturers only design for downward loading conditions.

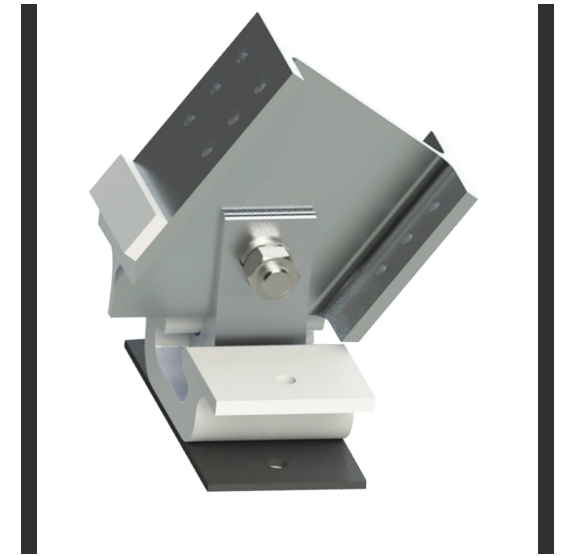

CENTER SAFETY LINE SUPPORT

Product safety is always a determining factor in our designs. Our rotating center tie off attachment is no exception. An APEX Domes center safety line support uses a hoist ring that is designed for 5,000 lbs. (2,268 Kg.) of lateral load for personnel safety.

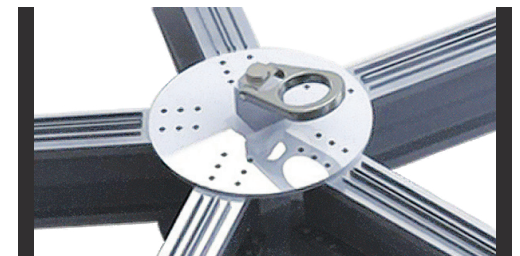

LIQUID STORAGE

APEX Domes covers are utilized for a wide variety of liquid markets including potable water, wastewater and petroleum.

WATER | Excellent corrosion resistance, affordable cost and leak resistance make APEX Domes ideal for municipal water.

WASTEWATER | In wastewater, APEX Domes offers specialized covers able to handle pressurized applications. They are also easily retrofitted to bolted, concrete and welded tanks.

PETROLEUM | Several emissions and roof configurations are available that are designed to provide superior vapor loss protection in the storage of petroleum.

BULK STORAGE

In dry bulk storage, APEX Domes alleviates environmental concerns by providing dust control and excellent protection against product loss. APEX Domes are custom designed for bulk handling and miscellaneous equipment loads. The strong clear span design minimizes foundation loads and maximizes storage capacity. Common types of storage include mining and industrial use, such as clinker, steel walls, drive-in access, limestone, coal and fly ash storage.



CUSTOMIZED DESIGNS



EMISSIONS & ROOF OPTIONS

APEX Domes provides a variety of options to protect against emissions. The advanced design and precision fabrication of an APEX dome provides superior vapor suppression to meet strict environmental standards and client requirements.

- TRADITIONAL EXTERNAL & INTERNAL FLOATING ROOF TANKS
- DOMED EXTERNAL ROOF TANK | SUSPENDED INTERNAL FLOATING ROOF
- INTERNAL FLOATING ROOF WITH DOME
- SUSPENDED INTERNAL FLOATING ROOF & DOMES

INTERNAL FLOATING ROOF & DOME

- Lowers emissions
- No columns to maintain
- No paint to apply or maintain
- Capacity gain at top (no internal rafters)
- Faster installation
- Option of suspending IFR to dome

EXTERNAL FLOATING ROOF & DOME

- Lowers emissions
- Increased EFR lifespan
- No paint to apply or maintain
- Eliminates weatherization from EFR
- UV protection from wear and fading
- Minimal time to decommission tank for dome installation

TAILORED TO YOUR SPECIFICATIONS

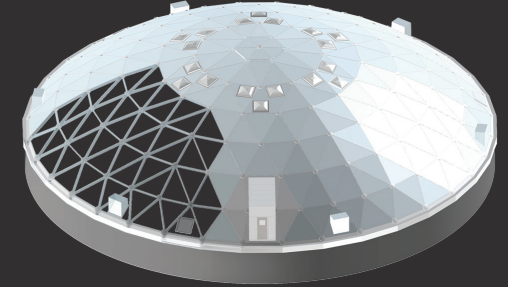

- INTERNAL WALKWAYS | WALL EXTENSIONS
- IFR & EFR DOMES | PRESSURIZED DOMES
- SPECIALIZED COATINGS | INTERIOR INSULATION
- ARCHITECTURAL DESIGNS | AUXILIARY COMPONENTS
- ROOF HATCH | DOOR ACCESS | ROOF DORMERS
- SKYLIGHTS | VENTILATION | HAND RAILS





SPECIALIZED COATINGS

APEX Domes offers the added durability of Kynar-500 coating for aluminum covers. This coating meets AAMA, API and AWWA requirements. Advantages include a factory-controlled application process, color matching, UV resistance to chalking and fading, corrosion resistance and flexibility.

INSTALLATION

APEX Domes can provide factory direct installation. The modular construction of geodesic domes allows for easy shipping and quick installation. Precision fabricated covers allow for exceptional ease of installation.

PSI PRESSURIZED APPLICATIONS

APEX Domes can be designed for pressurized applications with a design pressure of 10" W.C. and a working pressure of 4" W.C.

INTERIOR INSULATION

Interior insulation is available at up to three inches in thickness. The insulation panels can be applied on the ground, during assembly or after the dome is completed.



SPECIALIZED ENGINEERING

Wall extensions, dormers and internal walkways are often requested to be retrofitted to welded tanks or concrete basins for water treatment and clarifier applications. An APEX dome can also be designed to serve architectural and pressurized storage applications.



AUXILIARY COMPONENTS

APEX Domes is able to facilitate a variety of auxiliary dome components ranging from maintenance rails and perimeter hand rails to ventilation and sky lights.



RETROFIT APPLICATIONS

APEX Domes designs and installs stand-alone aluminum geodesic domes for bolted steel tanks, welded steel tanks as well as concrete tanks. In many instances, an APEX dome is sought out to replace an existing roof that is failing or if the customer wishes to add a cover to an open top tank.

BOLTED STEEL TANKS

FIELD WELD TANKS

CONCRETE TANKS & BASINS

ORIGINAL CONSTRUCTION

How do you top the #1 bolted storage tank selected worldwide? Put an APEX dome on it. The APEX Domes product line raises the bar in the industry for quality, design and customer service.

GOLDEN RULE CUSTOMER SERVICE

Tank Connection provides a full service approach to storage tank construction and field services. Whether it is consulting, project management or tank and auxiliary design, our Golden Rule customer service will meet and exceed client expectations.



PROJECT MANAGEMENT



MATERIAL TESTING + INSPECTION SERVICES



IN-HOUSE ENGINEERING



INSTALLATION SERVICES



CUSTOMIZED DESIGNS



CONSULTING SERVICES



DOMES COMPONENTS + ACCESSORY SERVICE



MAINTENANCE + REPAIR



CERTIFICATIONS

ISO 9001:2015

FM 4020/4021

NFPA 22

ISPM 15

REQUEST A QUOTE AND GET CONNECTED WITH REAL PERFORMANCE FROM THE INDUSTRY LEADER, TANK CONNECTION!



APEX DOMES: 3609 North 16th Street, Parsons, KS 67357
PHONE: +1 620.423.3010 | **EMAIL:** sales@tankconnection.com
WEB: APEXDOMES.COM | TANKCONNECTION.COM

STAY **CURRENT**
 STAY **CONNECTED**

