

# Fox Solids Conveying Venturi Eductor/Blower Solutions:

for Pneumatic Conveying of  
Bulk Solids when **Reliability**  
is Critical

## Feedback from Fox customers:

*"This eductor is in use for 3 shifts and we estimate it runs 5 1/2 days per week. It is used to blow metal chips through a 4" pipe...175 ft across the roof... The only maintenance this eductor has ever had (in 9 years) was (one adjustment) at start-up.*

Fox customer in  
Tennessee, USA - Jan 2002.

*"It's the best thing that happened on the project. No problems, works good, lasts a long time. Eight minutes per 3000 lb bag (of salt) Thanks."*

Fox customer in Ohio.  
April 2005.

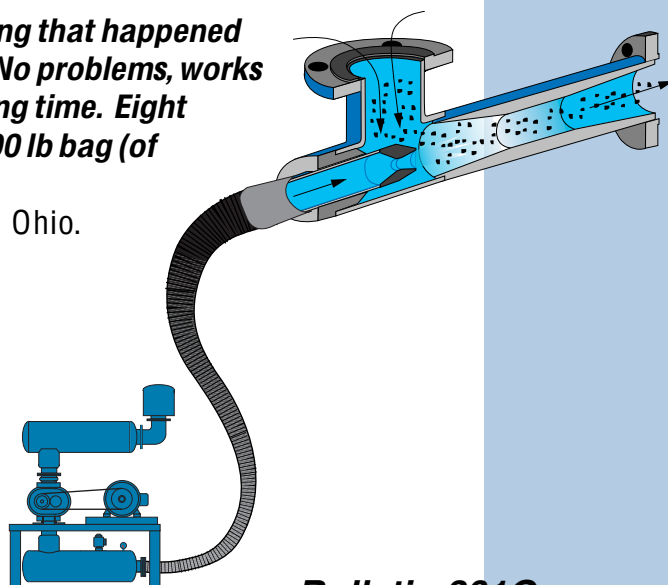

*"Actually, it wasn't worn out. We assumed it would be because it's transported several million pounds of feedstock. We took it apart ... but we discovered it was still in good shape ...."*  
Fox customer in Texas: May 2005.

**Since 1963...**

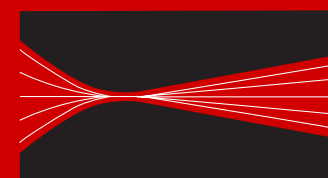

**F O X  
V E N T U R I  
E D U C T O R S**

Dover, NJ 07801 USA

973-328 - 1011

Fax 973-328 - 3651

[info@foxvalve.com](mailto:info@foxvalve.com)

[www.foxvalve.com](http://www.foxvalve.com)

Bulletin 301G - web

# Fox Venturi Eductors for Conveying Solids with No Moving Parts

- **No Maintenance**
- **No BlowBack**
- **Minimal Product Degradation**
- **Easy to Clean (CIP Versions)**

## Fox Venturi Eductors - What are they?

Fox Venturi Eductors use the positive air pressure from a blower to create suction that is then used to entrain and convey powders, pellets, and bulk solids in a pneumatic conveying system. Because they have no moving parts, they can operate entirely maintenance-free.

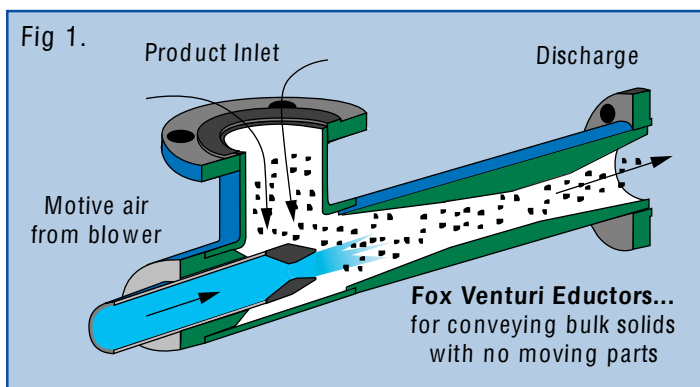

The eductor acts to compress the air/solids mixture to a pressure adequate to overcome losses in the downstream convey line. The eductor has three connections:

- Motive Air
- Suction or Product Inlet
- Discharge

## How are they used in pneumatic conveying systems?

Fox Venturi Eductors are used to feed bulk solids, such as cement, salt, ash, milk powder, shredded tires, and plastic pellets into positive, dilute-phase conveying systems. They are commonly used to replace rotary airlocks to eliminate blowback, maintenance, wear, and high maintenance costs. They are typically used with convey rates below 10 tons/hr and distances shorter than 400 ft (130 m)

Fox eductors are commonly installed under:

- Dust Collectors/Baghouses
- Screw Feeders
- Weigh belts and Screw Conveyors
- Mixers, Grinders, and Mills
- Bins, Silos, and Bulk-bag unloaders

## Who uses them?

Fox Venturi Eductors have been used since 1963 in thousands of installations by hundreds of companies in dozens of countries in dozens of different industries. Our database of eductor installations includes over 4000 different applications representing well over 10,000 installed venturi eductors.

## Why are eductors used in pneumatic conveying systems?

• **Fox Venturi Eductors have no moving parts.** This enables maintenance-free conveying - like those testimonials on front cover. When high reliability is needed in your conveying system, whether handling activated carbon or spices or cement — venturi eductors are the obvious solution.

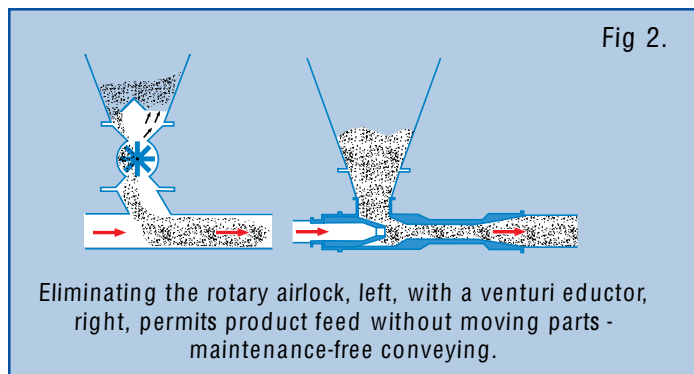

• **No Blowback** - All rotary airlocks have blowback. If the product conveyed is fine or abrasive, blowback can cause extreme wear problems, high maintenance costs, low flow rates, and a dusty workplace

### • Different Eductors for Different Applications -

Over the last 40 years, Fox has developed a wide variety of standard venturi eductors, often maintained as stock items that can ship in 1-2 weeks. In addition to standard carbon steel and stainless eductors, Fox also makes:

- Ceramic & Tool-Steel Lined Eductors
- Sanitary/Hygienic/CIP Eductors (for food & pharma)
- Enlarged Suction Port Eductors

See Page X for photos of these eductor types.

### • Provided with Matched Blowers

Fox eductors are typically provided with matched blowers so that we can guarantee meeting the requirements of your applications. We provide side-channel and pd blowers and any additional accessories required, including hoppers, controls, etc. We have global sources for blowers for shipments to users in Europe, Asia, and elsewhere.

## How are they designed? How are they tested? Are they guaranteed to work?

Fox's eductor designs have been exhaustively tested. We have 40+ years of hands-on experience to draw upon. And we have a well-instrumented test lab. This enables Fox to Performance Guarantee every quotation for an integrated blower+eductor system we ship.

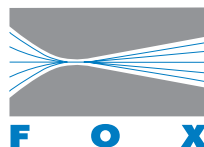

**Fox Venturi Eductors**  
Dover NJ USA  
info@foxvalve.com

# The Ten Most Commonly Asked Questions About Fox Venturi Eductors

**1) Don't they need evenly metered feed or they'll clog? Wouldn't a full 'head' of product 'overfeed' the eductor?**

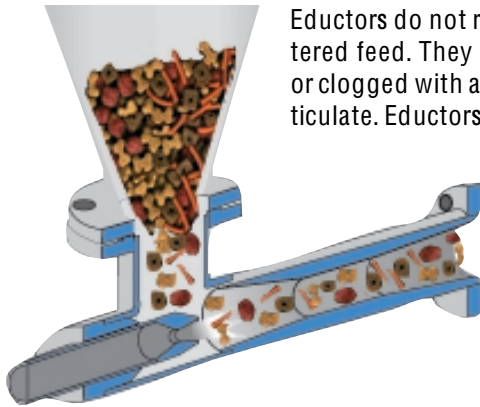

Eductors do not require evenly metered feed. They cannot be overfed or clogged with a freely flowing particulate. Eductors are self-metering.

Fig 3

**2) Don't eductors need compressed air to work?**

No. 98% of all Fox eductors we sell use air at below 12 psig, with about half of them using air at below 4 psig. Only if electricity is free at your plant does it make sense to consider using air at 60 - 100 psig (3 - 5 barg). Fox can provide a perfectly matched blower that will reduce energy cost 60 - 80% from using compressed air.

**3) Why Fox? Other companies claim they can make venturi eductors for conveying solids. We even made one ourselves that sorta works - sometimes. What does Fox know that others don't?**

A very great deal. Fox is the only company that sponsored a two year research effort that included hundreds of empirical flow tests with many different products, ranging in bulk densities from 5 to 150 lbs/ft<sup>3</sup> conveyed over distances from 50 ft to 200 ft. This data was then collated into algorithms for quickly predicting eductor performance for any pipe geometry with any solid. Couple this with the 4000+ existing applications we have sold to industry since 1963, and we think we have a pretty good knowledge base to work with.

**4) What conveying velocity does Fox design around? What controls velocity?**

The same as any other pneumatic conveying system. Fragile products can be conveyed slower; cohesive products may be conveyed faster. Fox eductor systems can also include, at surprisingly low added cost, features to allow users to easily adjust/minimize convey velocity as required - very important when conveying fragile materials like warm pellets, snack foods, peanuts, prills, etc. Each eductor is carefully machined to match the Fox blower and to flow the right amount of conveying air into the pneumatic system.

**5) If Fox eductors are so great at conveying reliably with no moving parts, how come big system designers almost never include them, where appropriate, in the plants they design?**

If the most profitable part of your business was selling rotary airlock spare parts, would you introduce your customers to venturi eductors that just keep working on and on and on?

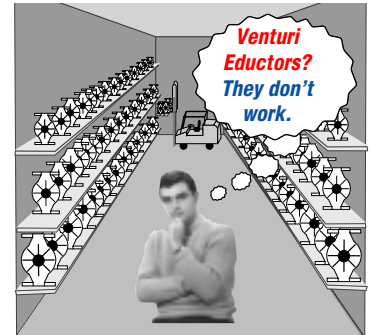

**6) Is there a simple "Rule of Thumb" we can use to predict how much air we need?**

No. Too many factors are involved in the design of a pneumatic conveying system. To get a quote on the right blower /eductor sub-system guaranteed to meet your specific requirements, just complete the Data Sheet on the last page of this pdf and fax. You'll usually get a quote in 1 - 2 days.

**7) Can we have our material tested? Can we witness these tests? Can you run degradation trials?**

Yes to all. Most products already appear on our list of 4000 existing installations, so we do not normally need to run tests to predict flow rates and blower sizing.

(See Fox test rig at right.)

Predicting degradation with fragile products often does require testing.

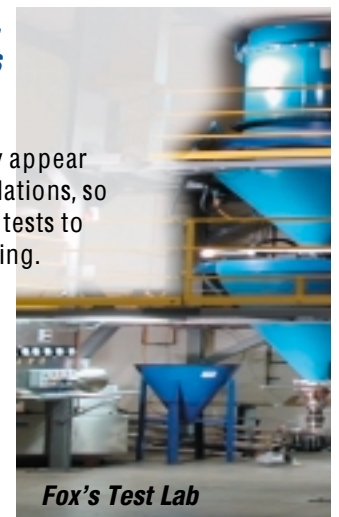

**8) We need to convey very hot materials. What temperatures can they handle?**

A stainless eductor (316 ss) can work happily at 1100 - 1200° F. For temps up to 1600°, we'd just build it in Inconel.

**9) How does an eductor control the feed rate?**

It does not. Eductors cannot be used to regulate convey rates. However, do not interpret this to mean they must have controlled feed or they will clog. Fox eductors sit under wide-open ports below silos, bins, and bulk bags and convey material at their max convey rate

**10) How long does it take to get them?**

Fox has a large range of standard eductors ranging from one to six inches (25 - 150 mm) in ss, cs, and ceramic-lined that can all ship in one week. Blowers can ship in 1 week for Rotron blowers and 4 - 8 weeks (for pd blower packages). Expediting is always an option.

Fox Venturi Eductors  
info@foxvalve.com

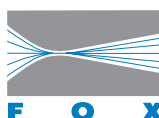

## Where Does MY Industry Use Fox Eductors?

Fox eductors are used in almost every industry that requires bulk solids handling. Below is a just a sample from over 4000 installations made since 1963.

### Building Products:

**Conveying:** Phenolic resin and sawdust for chipboard; Gypsum for sheetrock; Pumice powder for grout; Roofing granules;

### Cement

**Conveying:** CKD at up to 800° F; Portland cement at up to 20,000 lbs/hr; Alternate fuel injection (shredded carpets/plastic/tires//paper; biomass, rice hulls.) Kiln spill at 1600° F

### Ceramics/Glass:

**Conveying:** Silica, Glass Frit, Ceramic pellets, Ceramic dust, Mica

### Environmental:

**Conveying:** Activated Carbon, Sodium Bicarbonate, Hydrated Lime, Pulverized Limestone into ducts and stacks; Sorbent injection in fluidized bed boilers for SOx reduction,

### Food:

**Conveying:** Minor ingredients to mixing/batching (salt, sugar, spices, vitamins, flavorings, etc.); Milk powders from spray dryers; Coffee beans from bulk bags; Powdered tea from screeners; Rice; Breakfast cereal from coating reels; Snack food extrudate from extruders; Frozen peas from IQF; Whole peanuts from sorters;

### Foundries:

**Conveying:** Foundry dust from dust collectors; Inoculant to cupolas; Metal grit from grinding stations; Sand and bond

### Hygienic/Diapers/Paper:

**Conveying:** SAP from feeders with uniform flow distribution

### Minerals/Mines:

**Conveying:** Hot copper and nickel alloys at 1000° F from calciners; Mica, talc, quartz, and perlite ore from dust collectors; Copper pellets at 400 lbs/ft<sup>3</sup> bulk density;

### Plastics:

**Conveying:** Plastic pellets with reduced angelhair and fines from hundreds of extruders and compounding lines since 1963; 50+ fiberglass filled pellets with Clean-in-place, ceramic-lined wear resistant eductors; Conveying plastic regrind and flakes that jam airlocks in 10 minutes;

### Power/Incineration

**Conveying:** Coal, coke, and alternative fuels; Additives for inhibiting slag build-up on boiler tubes; sorbents for SOx reduction in CFB's; Activated carbon, lime, calcium carbonate, Trona injection for flue gas desulfurization (FGD)

## But Can Venturi Eductors Convey MY Product?

**Let's Start with the letter:**

# A

*Fox maintains a database of all 4000+ installations made with Fox venturi eductors. Below is a list of those products successfully conveyed with eductors that start with the letter 'A.' Do you think there's a good chance we've conveyed YOUR product?*

Abrasive/ Blast Grit  
Absorbent, SAP polymer  
Acid Pellets  
Acid Powder, Organic"  
Acrawax  
Acrylic Acid/Copolymer  
Acrylic Flake  
Act Carb +Hy'd Lime  
Activated Carbon  
Activated Charcoal  
Additive  
Adhesive, Dry  
Adipic Acid  
Adipic Acid Fines  
Aerogel  
Aerosil  
Aggregate/gravel  
Aggregate Dust  
Alamin  
Alginate  
Almond Chips  
Almond Meal  
Almonds  
Alum Salt  
Alum, Spent (ALOH)  
Alumina  
Alumina Brick,  
Alumina Catalyst  
Alumina Dust  
Alumina Granules  
Alumina Hydrate  
Alumina Monohydrate  
Alumina Silica Powder  
Alumina Silicate  
Alumina Slugs  
Alumina Sulfate  
Alumina Trihydrate  
Alumina/Cerium Powder  
Aluminium Chips  
Aluminum Oxide  
Aluminum, Shredded  
Aluminum + Plastic flakes  
Aluminum Chloride

Aluminum Chlorohydrate  
Aluminum Dioxide  
Aluminum Dross  
Aluminum Flakes  
Aluminum Foil trim  
Aluminum Hydrate  
Aluminum Oxide  
Aluminum Oxide Grit  
Aluminum Pellets  
Aluminum Powder  
Aluminum Silicate  
Aluminum Strips  
Aluminum Wire, Chopped"  
Amersorb  
Ammonium Bicarionate  
Ammonium Bichromate  
Ammonium Chloride  
Ammonium Sulfate  
Ammonium Triosulfate  
Anamol Oxide  
Anthracite  
Anthracite Fines  
Anticaking Agent  
Anti-perspirant Powder  
Apple Bits  
Apple Bits + Almonds  
Apple Crumblets  
Artificial Sweetener  
Asbestos Fines  
Ascorbic Acid  
Ash  
Ash & Limestone  
Ash, Film w/silver at 600°F  
Ash + Cement  
Ash, Flyash at 300° F  
Ash, Boiler  
Ash, Bottom  
Ash, Filter  
Ash, Pyrolyzed  
Ash, Rice Hull  
Aspartic Acid  
Atrazine  
Attapulgitte Clay, Processed

**Please contact us** about our specific experience conveying YOUR Product.

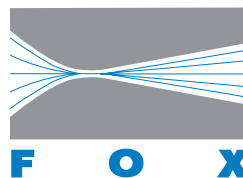

**Fox Venturi Eductors**  
Dover NJ USA  
info@foxvalve.com

# Where To Use Educators in a Pneumatic Conveying System

Here are six common applications. There are hundreds more.

## Replace Rotary Airlocks

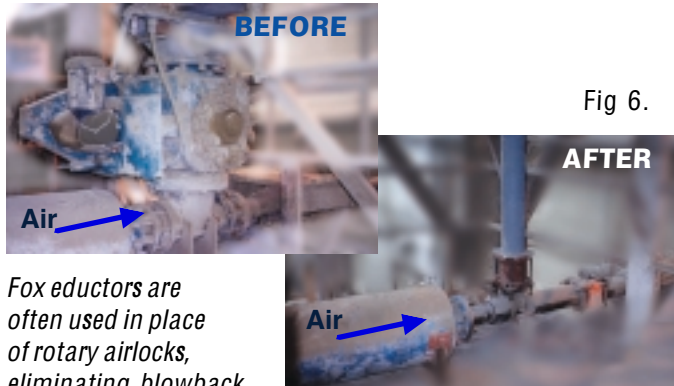

Fig 6.

Fox educators are often used in place of rotary airlocks, eliminating blowback, an extra motor, and providing much more reliable conveying.

## Conveying to Kilns & Boilers

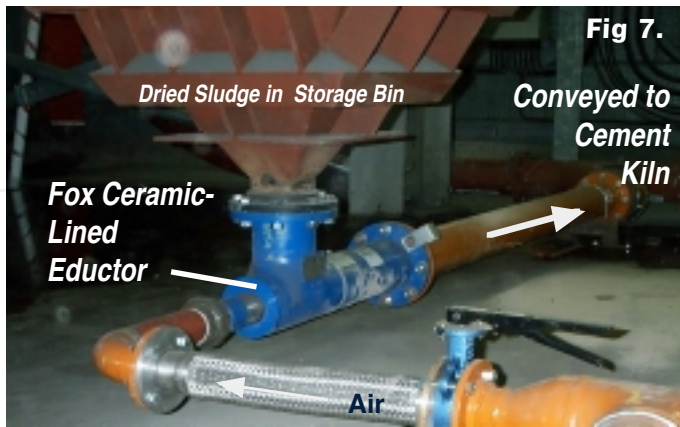

Fig 7.

This Fox educator is conveying dried sewage sludge to a cement kiln in England using air at 12 psig (0,8 barg)

## Under Screw Feeders



Fig 8.

Fox educators are installed under hundreds of screw feeders. Of course, there is no blowback up into the feeder. Typical applications include combustion and pollution control additives and spices in food production

## Under Dust Collectors



One pd blower is used to drive five Fox educators conveying dust from five dust collector outlets. No blowback, no maintenance, and no moving parts.

## Pollution Control: FGD; Activated Carbon, etc

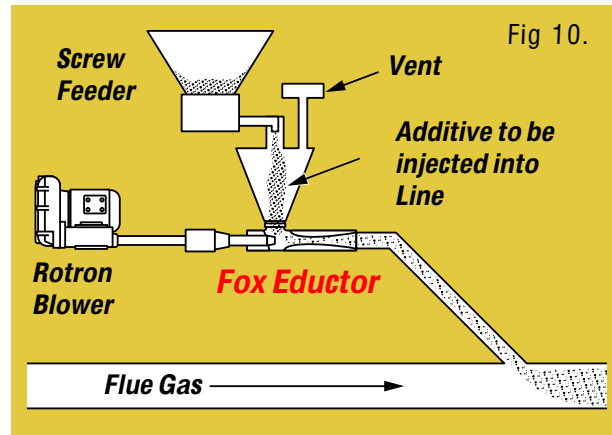

Fig 10.

Hundreds of Fox educators are used to convey additives when 24/7 reliability is imperative - eliminating possible use of rotary airlocks.

## Conveying HOT Minerals

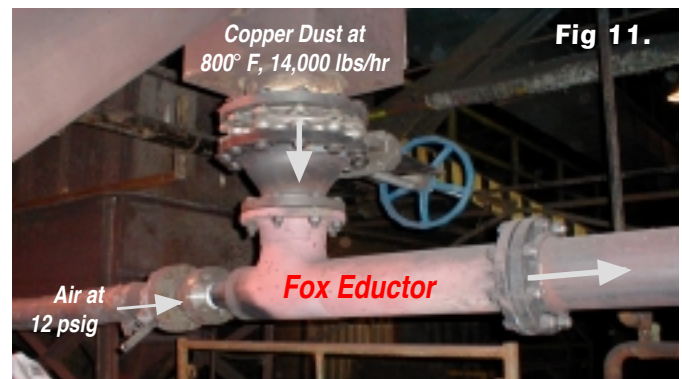

Fig 11.

There is no more reliable way to convey hot cement, minerals, or ash from kilns, reactors, or calciners than using educators.

# What Type of Eductors are Available?

Fox has developed a broad family of eductor designs and styles. Many of these eductor types, which may sound like specials, are in fact maintained in stock and can be shipped in just a few days. For many applications, a perfectly matched side-channel blower can also ship in just a few days

## Standard, Off-the Shelf Eductors

Fox maintains large inventories of stock eductors.

- **Line Sizes: 1/2" to 6"**
- **Materials: 304 ss, 316 ss, Carbon Steel**
- **Sanitary/Hygienic, CIP Eductors: 1" - 4"**
- **Ceramic-Lined Eductors: 1-1/2" - 6"**
- **End Connections : NPT, BSP, Flanged,**

Of course, eductors can be ordered in any material such as Inconel, Monel, Hastelloy, ceramic-spray coated, high-release coated, etc.

## Fox Ceramic-Lined Venturi Eductors

Highly abrasive products can cause excessive rotary valve wear that can shut down operations. Fox ceramic-lined eductors are to be used with erosive products when long service life and reliability are paramount.

Hardened tool-steel liners are used for high temperatures.

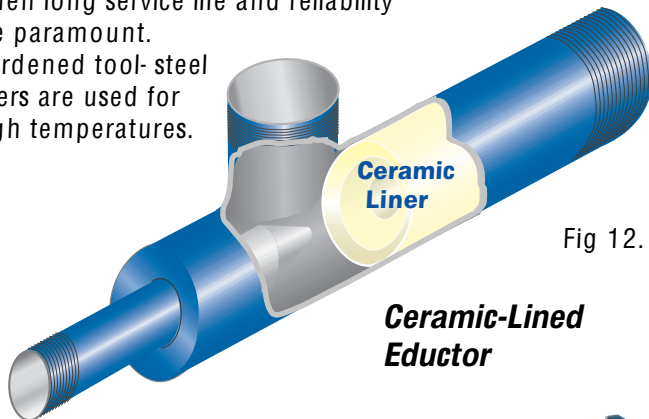

Fig 12.

**Ceramic-Lined Eductor**

## Cart and Skid-Mounted Eductor Systems

Unlike airlocks and p-d blowers, a complete eductor/Rotron conveying system can be neatly assembled on a small skid. Smaller systems can be cart-mounted and moved to different extruders, screeners, grinders, or other equipment as needed.



Fig 13.

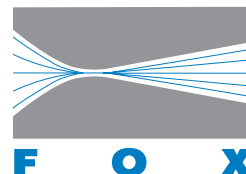

## Fox Venturi Eductors

Dover NJ USA

Voice - 973 328 1011, Fax - 3651  
info@foxvalve.com

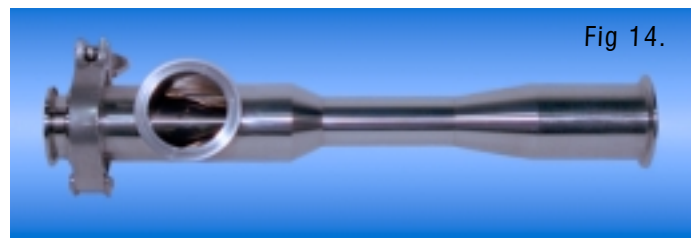

Fig 14.

## Enlarged Suction Port Eductors/ Integral Inlet Transitions

The product inlet to Fox eductors does not need to be round nor small. To facilitate installation below dust collectors, or the handling of irregularly shaped materials, Fox eductors are often supplied with large rectangular openings that match exactly to existing flanges. Enlarged Suction Ports are recommended when handling shredded waste (tires, paper, carpets), chopped cable, fibers, biomass (rice hulls, crushed seeds) or any materials that may bridge above a small opening.

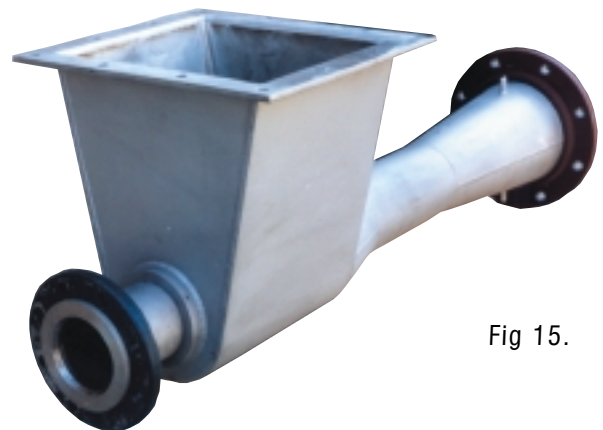

Fig 15.

# Detailed Info About Venturi Eductor Applications in YOUR Industry

Please request the Fox brochure you need, along with some details of your specific application, and a pdf version can be emailed asap.  
Email to : [info@foxvalve.com](mailto:info@foxvalve.com)

## Convey **CEMENT** with Fox Venturi Eductors

*Convey: Cement, CKD, Limestone,  
Flyash, Kiln Spill at 1600°F*

*Alternative Fuel/ Waste:*

*Shredded Tires, Shredded Carpet,  
Plastic Scrap; Dried Sludge,  
Rice Hulls, Crushed Seeds*

**Bull 307**

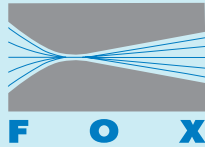

*Flue Gas Conditioning, Ash  
Conditioning and FGD with:*

**Fox Venturi Eductors**  
*Pneumatically Convey*  
*Activated Carbon*  
*Calcium Carbonate*  
*Sodium Bicarbonate*  
*Gypsum/Kaolin*  
*MgO*  
*Limestone*  
*Soda Ash/Trona*  
*with No Moving Parts*

**Bull 305**  
Fox Venturi Eductors



## Fox Venturi Eductors Convey **Plastic Pellets, Flakes, and Regrind**

with  
No Moving Parts

**Bull 336**

Fox Venturi Eductors

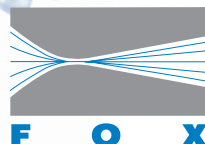

## **Fox** Venturi Eductors in the Food Industry



**Bull 350**  
Fox Venturi Eductors

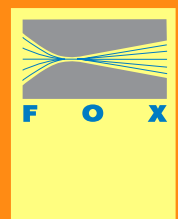

# How Much of the Conveying System Can Fox Provide?

## Blowers

All eductors require a source of conveying air, which is typically supplied by a blower at below 14 psig. Every year, Fox supplies hundreds of Eductor/Blower subsystems, providing a perfectly matched blower to the required eductor. (For more info on these sub-systems, **Request Bulletin 302**) Any type, or make of blower can be provided but most fall into the following two categories:

- **Rotron blowers** – output to 6 psig.
- **Positive Displacement blowers** – to 15 psig.

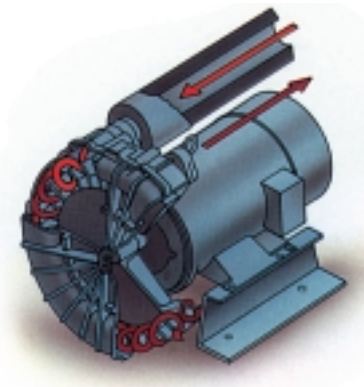

*Fox has supplied hundreds of small, quiet, highly reliable Rotron blowers as part of our pneumatic conveying solutions*

Fig 16.

## • Hoppers, Inlet Funnels, Transitions

Fox can provide custom-fabricated hoppers and transitions. Design options are virtually unlimited and frequently include features such as multiple inlets, vent and access ports, hinged lids, grates, or screens. Special coatings and food-grade finishes are also available

## • Diverter Valves:

Fox has supplied many diverter valves to enable our eductor driven convey systems to deliver material to multiple destinations

## • Slide Gate Valves:

These valves are used to open and close the hopper, bulk bag, or silo atop the eductor.

## • Cyclones, Dust Collectors

It is very important to use a correctly specified air/solids separator for your eductor system, which Fox can provide.

## • Controls

Fox can provide the motor controls, level detectors, and other controls.

## • Elbows and Clamps

Fox can provide the wide radius bends and compression couplings needed to install a properly engineered pneumatic convey line.

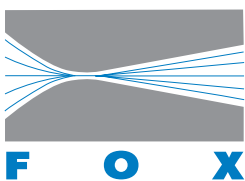
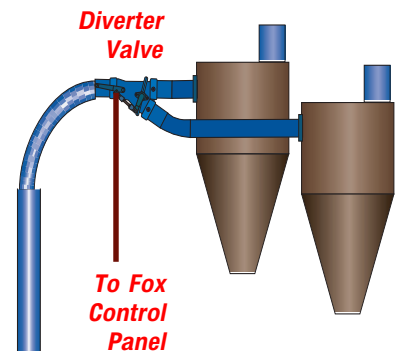

## Fox Venturi Eductors

Dover NJ USA  
Voice - 973 328 1011, Fax - 3651  
info@foxvalve.com

Fig 17.

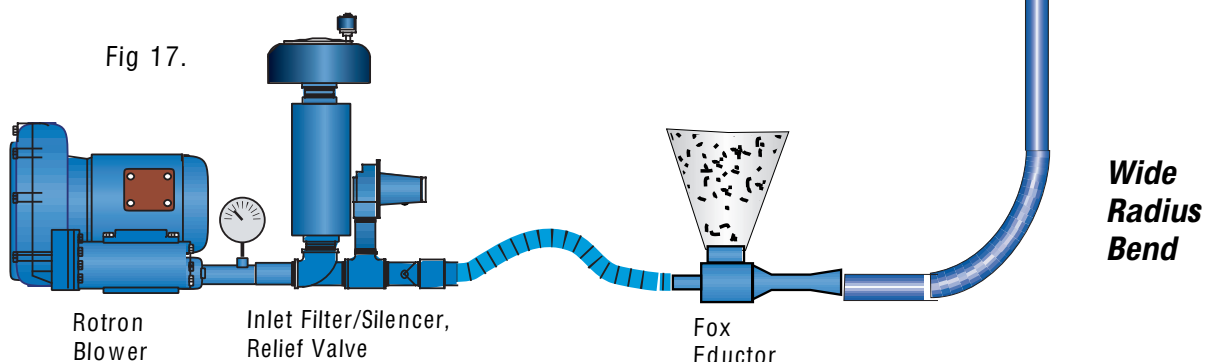



Give Away the Razors... *Sell the Blades ...*

# Why There's Always a Low Cost Rotary Airlock You Can Buy!

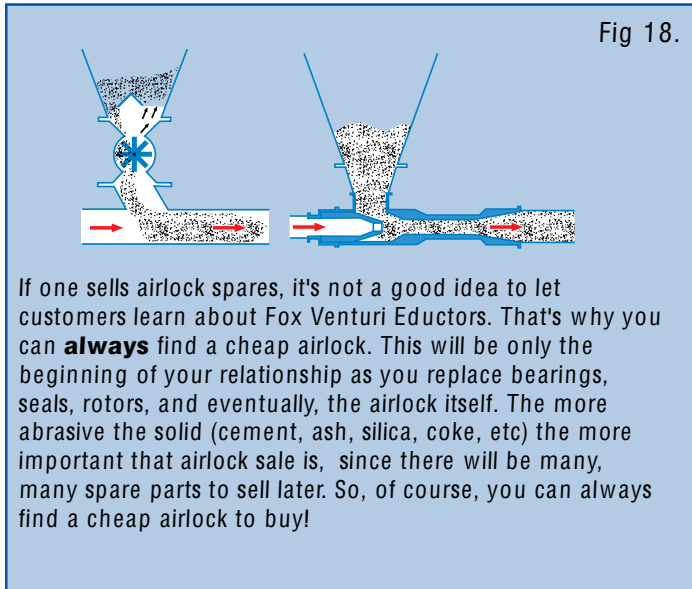

## Venting Blowback from Existing Rotary Airlocks...

**Fox Rotary Valve Venting Eductors** (RVE's) are used to suck blowback air + suspended solids out of the airlock and pneumatically convey them to the destination of choice: bin or silo located above, or the convey line .

### What results can we expect from a retrofit with a Fox RVE Venting Eductor?

It depends on how bad your blowback problem was in the first place. But over the last 25 years, we've seen the following widely varied results:

- **Increase in Airlock Feed Rates**
- **Decreased Wear , Increased Service Life**
- **Fugitive Dust - Eliminated**
- **Leakage & Waste - Eliminated**
- **Blowback into Screeners - Eliminated**

## Retrofitting/Replacing Existing Rotary Airlocks...

For many reasons, we speak to hundreds of customers anxious to replace their existing rotary airlock with a Fox eductor. The simple answer is that sometimes this is possible, and sometimes this is not.

In this highly competitive sales environment, there is pressure from all parties to reduce costs , particularly if the airlock conveying system was but small component in a larger project. For this reason, the blower and piping are often somewhat undersized, pushing the airlock to the ragged edge of performance and creating the blowback, wear, and failure problems that invite a call to Fox Venturi Eductors.

Replacing an airlock in an existing convey line with a Fox eductor may require changes to the blower or convey line. Fox engineers will provide all necessary sizing information upon receiving a completed Application Data Sheet.

Engineering a venturi eductor into a system at an early design stage is far easier than retrofitting existing equipment.

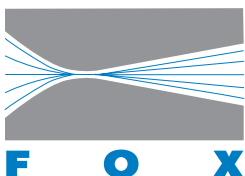
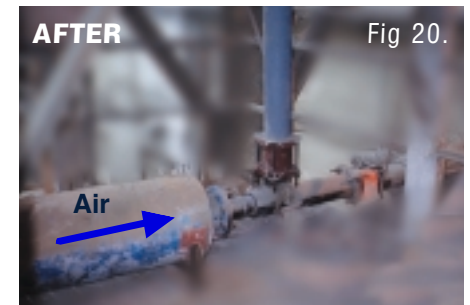
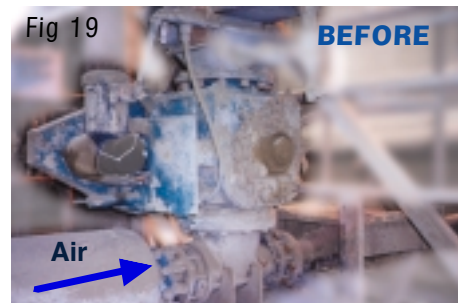

**Fox Venturi Eductors**  
Dover NJ USA  
Voice - 973 328 1011, Fax - 3651  
info@foxvalve.com

# Additional Technical Literature Available Upon Request

To receive any of the following technical information, please just contact us ( email, fax, or phone) and request this literature, along with a brief explanation of your possible application:

## Brochures

- **Cement** Plant Applications - Bull. 307
- **Food** Industry Applications - Bull. 350
- **Flue Gas Conditioning**/Additive Injection into Ducts with Fox Systems - Bull. 305
- **Plastics** Industry Applications - Bull. 336
- **Power** Industry Applications - Bull. 308
- **Foundry** Applications - Bull. 317
- Fox **Blower/Eductor** Systems using Rotron or PD Blowers - Bulletin 302
- Venting **Blowback** from Airlocks with Fox RVE Eductors - Bulletin 360
- **Slurry Eductors** for Liquid/Powders - Bull. 106
- **Air Ejectors** - Bull. 251
- **Steam Ejectors** - Bull. 201
- **Water Eductors** - Bull. 101

## Published Case Histories/Reprints

- Ten Years of Maintenance-Free Conveying with Fox eductors at metal processor
- Cement - Convey Kiln Spill at 700° C with No moving parts
- Cement - Convey waste/alternative fuels into cement kiln with 24/7 reliability
- Power - Spent Bed Recirculation, at high temps, at fluidized bed cogen plant
- Power - Dried sludge injection at cogen power plant
- Pigment powders at dye mfr.
- Foundry: Spent sand Conveying and dust collector retrofit
- Limestone Dust at Mexican mine
- Convey Dense Metal powders at magnet producer

## Case Studies

Fox constantly publishes new Case Studies as our venturi eductors are applied by new customers in new applications conveying new products. Here is just a partial list of case Studies that can be emailed or faxed to you upon request, grouped by industry. Request the Case Study You need by the Case Study Number:

### Food:

- 63 Corn snacks from extruder
- 59 Frozen cranberries
- 55 Puffed rice from reel
- 50 Oat bran from dust coll.
- 49 Ground coffee; screener
- 42 Cereal; package reclaim
- 39 Sugar; bulk bags
- 34 Whey; spray dryers
- 24 Salt flakes; screw feeder
- 17 Minors; spices - screw fdr.

### Plastics

- 45 Cryogenic grinding; mill
- 44 Screener - overs/unders
- 47 Acrawax feed to line
- 4 Reduce streamers and angelhair

### Diapers/ Hygenic

- 84 SAP/ Absorbant polymer in diaper production

## Power/Environmental

- 52 Hydrated lime, FGD
- 6 Flyash at 700° F
- 71 Boiler additive injection
- 72 Activated Carbon inj. into ducts
- 27 Pulverized Limestone, screw feeder
- 78 Dried sludge at cogen plant
- 74 Alt fuels; shredded waste

## Building Products

- 79 Pumice/grout from dust collectors
- 83 Ground Cement Boards
- 85 Phenolic Resin at chipboard plants
- 20 Copper pellets, 400 pcf

## Minerals/Mines/ Metals

- 20 Copper pellets at 400 pcf
- 70 Copper-based caalciate @ 700\* F
- 81 Shredded Aluminum
- 20 Copper pellets, 400 pcf

## Cement

- 74 Inject alt fuels/waste ( shredded tires, carpets) into cement kiln
- 80 CKD @ 700\* F
- 77 Dried sludge into kiln

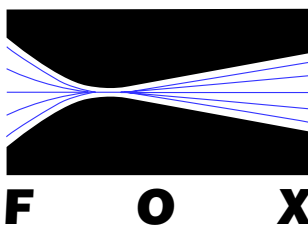

**Fox Valve Development Corp.**  
**Hamilton Business Park**  
**Dover, NJ 07801**  
**973-328-1011 Fax 973.328.3651**  
email: [info@foxvalve.com](mailto:info@foxvalve.com)  
website: [www.foxvalve.com](http://www.foxvalve.com)

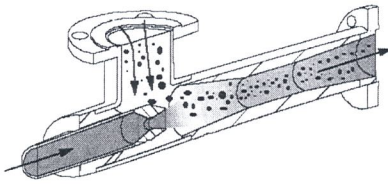

# Fox Venturi Eductors from Fox Valve

Dover, NJ 07801 / [www.foxvalve.com](http://www.foxvalve.com)

Phone: (973) 328-1011 / Fax (973) 328-3651

E-Mail: [info@foxvalve.com](mailto:info@foxvalve.com)



## Application Data Sheet for Fox Solids Conveying Eductors

Please provide the requested information so that Fox can prepare a quotation on a performance-guaranteed eductor/blower system.

Company Name: \_\_\_\_\_ Contact Name: \_\_\_\_\_

Company Address: \_\_\_\_\_

Phone: \_\_\_\_\_ Fax: \_\_\_\_\_ E-Mail: \_\_\_\_\_

Material To Be Conveyed: \_\_\_\_\_

Bulk Density: \_\_\_\_\_ lb/ft<sup>3</sup> Particle Size: \_\_\_\_\_ Temp.: \_\_\_\_\_ °F

Max Allowable Temp. (if temp sensitive): \_\_\_\_\_ °F Free Flowing?: \_\_\_\_\_

Moisture/Fat Content: \_\_\_\_\_ Abrasive Characteristics: \_\_\_\_\_

Required Solids Flow Rate: Nominal: \_\_\_\_\_ lb/hr Max.: \_\_\_\_\_ lb/hr

Distance Material is to be Conveyed: Horiz.: \_\_\_\_\_ ft. Vert.: \_\_\_\_\_ ft.

Number of Elbows: 90°: \_\_\_\_\_ 45°: \_\_\_\_\_ Other: \_\_\_\_\_

Do you have an existing convey line?:  Yes  No If so, line size: \_\_\_\_\_ Sch./ID: \_\_\_\_\_

Gravity Feed?:  Yes  No What is eductor fed from?: \_\_\_\_\_

Should Fox quote hopper or transition?:  Yes  No (If yes, please provide sketch)

What is eductor conveying into?: \_\_\_\_\_ Pressure Here: \_\_\_\_\_

Required Material of Construction:  Carbon Steel  Stainless Steel  Wear-Treated  Sanitary

Preferred End Connections:  NPT  Plain Pipe  Flange - \_\_\_\_\_  
 Tube (inch OD)  Tri-Clamp  Other: \_\_\_\_\_

Preferred Blower Type:  Regenerative  P-D  Other: \_\_\_\_\_

Is there an existing blower on-site?:  Yes  No If yes, blower model: \_\_\_\_\_

Air Flow Rate: \_\_\_\_\_ Pressure: \_\_\_\_\_ Motor HP: \_\_\_\_\_

Special Requirements: \_\_\_\_\_

Please provide a sketch of your pneumatic conveying system.